

MARSDEN

USER MANUAL

MBF-6000

MBF-6010

Please take time to read these
instructions before starting
to use the scale



Contents

Product Specification	3
Safety Instructions	4
Maintenance & Cleaning	5
Graphic Symbols	6
Model Structure: MBF-6000	7
Model Structure: MBF-6010	8
Product Assembly (MBF-6010 only)	9
Before Operation	10
Setting Date & Time	11
Operation Instructions	12
Assembly Instructions: HM-201D	14
Replacing the Battery	15
Print-out Readings Explained	16
Body Impedance Measurement Methods	17
Error Messages	18
ROHS Compliance	19
EMC Guidance & Manufacturer's Declaration	20
Manufacturer's Declaration of Conformity	23

Thank you for purchasing a Marsden professional medical scale. This is a precision Class III Weighing Instrument and considerate use will result in many years of accurate weighing.

The scale has a maximum load capacity of 300kg which must not be exceeded.

Model	MBF-6000/MBF-6010
Accuracy Class	Class III
Capacity/Division	300kg x 100g Body Mass Index (BMI) 0.1 increments Basal Metabolic Rate (BMR) 1 kcal increments Fat % 5-50% / 0.1% increments Fat Mass (FM) 0.1kg increments Fat Free Mass (FFM) 0.1kg increments Total Body Water (TBW) 0.1L increments Bone Mineral content (BM) 0.1kg increments Muscle Mass (MM) 0.1kg increments Protein Mass (PM) 0.1kg increments Intracellular Water (ICW) 0.1L increments Extracellular Water (ECW) 0.1L increments Skeletal Muscle Index (SM) 0.1kg/m ² increments Visceral Fat Area Level (VFA) 1 level increments Metabolic Age (AGEM) 0.1 year increments Body impedance 0.1ohm increments Health score 1% increments
Weight of Scale	9.5 Kg (MBF-6000) 12.5 Kg (MBF-6010)
Units of Measure	Kg
Function Keys	ON/OFF, ATHLETIC, MALE/FEMALE, ZERO, TARE, TIME, PRINT, 0-9
Base dimensions	340mm x 450mm x 80mm
Operating Temperature	0 to 40°C
Power Supply	7.2v 2000mA rechargeable battery or AA (1.5x6) 9V batteries. Medical switch AC adaptor 12V 2A UE24WV-120200SPA & UE24WB-120200SPA
Display	2cm LCD display (three row LCD)
Measurement System	4 Polar Bioelectrical Impedance Analysis
Measurement Current	50kHz 500uA
Measurement Style	Left leg; right leg
Measurement Range	200 ~ 1000Ω /0.1Ω
Input Items	Gender: Male/Female Body Type: Standard/Athletic Age: 10-80 years old Height: 60-210cm / 2ft-7ft 11.0in

Safety Instructions

Before putting the device into use, please read with care the information given in this user manual, which contains important instructions for proper installation, use and maintenance of the device.

When the scale is switched on, the display should read 0.0. If it doesn't, press the ZERO key.

The device is designed to detect when a stable weight is achieved. The indicator will beep twice to indicate a stable weight value, at which point your reading can be taken.

Marsden/the manufacturer shall not be liable for damages arising from failure to heed the following instructions:

- When using electrical components under increased safety requirements, always comply with appropriate regulations.
- Inappropriate installation/use will render the warranty null and void.
- Ensure the voltage marked on the power supply unit matches your mains supply.
- This device is designed for use indoors.
- Observe the permissible ambient temperatures for use.
- The device meets the requirements for electromagnetic capability. Do not exceed the maximum values specified in the applicable standards.
- Batteries should be kept away from small children. If swallowed, promptly seek medical assistance.

If you have any problems, contact Marsden/your local dealer/your service partner.

- ⚠ **WARNING TO INDIVIDUALS WITH A PACEMAKER OR OTHER INTERNAL MEDICAL DEVICES:** This scale sends a weak electrical current through the body during measurements. Individuals who have internally implanted medical devices, such as pacemakers, should not use this medical equipment due to the risk of malfunction to the device that may be caused by the weak electrical current.
- ⚠ Do not use this scale if you are pregnant.
- ⚠ To reduce the risk of electrical shock or product damage, never insert or remove the power cable with wet hands.
- ⚠ Do not under any circumstances dismantle or alter the device, as this could result in electric shock or injury as well as adversely affecting the precision of the scale's measurements.
- ⚠ Use only a correctly wired (100-240V AC) outlet, and do not use a multiple outlet extension cable.
- ⚠ Physically disabled persons should not attempt to take measurements alone, but instead should be assisted in using the device.

Maintenance

The scale does not require any routine maintenance. However, we recommend checking the scale's accuracy at regular intervals. If any inaccuracies occur, please contact Marsden, your local dealer or service partner.

Cleaning

- We recommend using alcohol-based wipes or similar when cleaning the scale. Do not wipe the platform with strong chemicals.
- Please do not use corrosive liquids, large amounts of water or high pressure washers.
- Always disconnect the scale from the mains power supply before cleaning.

 This scale should be used with bare feet. Please be sure to clean the scale platform with appropriate disinfectant after each use.

 Never disassemble the equipment as this may cause malfunction.

Disposing of the Scale

- This product should not be treated as regular household waste, but should be handed in to an electrical/electronic equipment recycling centre.
- You can obtain further details from your local council, your municipal waste disposal company or from where you purchased the product.

General Information

- We strongly recommend you use this device on a flat and hard surface. Any soft surface, like carpet, may cause inaccuracy.

Explanation of Graphic Symbols

SN-21300100

Designation of the serial number of every device.
(Number as an example)



“Please note the accompanying documents” or “Observe operating instructions”



Identification of manufacturer of medical product including address.

Charder Electronic Co. Ltd
No.103 Guozhong Rd, Dali Dist,
Taichung City 412, Taiwan (R.O.C)



“Type BF applied part”



Dispose of old appliances separately from your household waste.
This product must be disposed of at a communal collection point.



Carefully read this operation manual before setup and commissioning, even if you are already familiar with Marsden products.

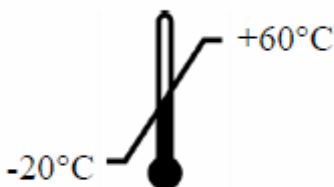

Transport and storage temperature limit indicating the upper and lower limit (transport and storage temperature on packaging).

Product Structure: MBF-6000

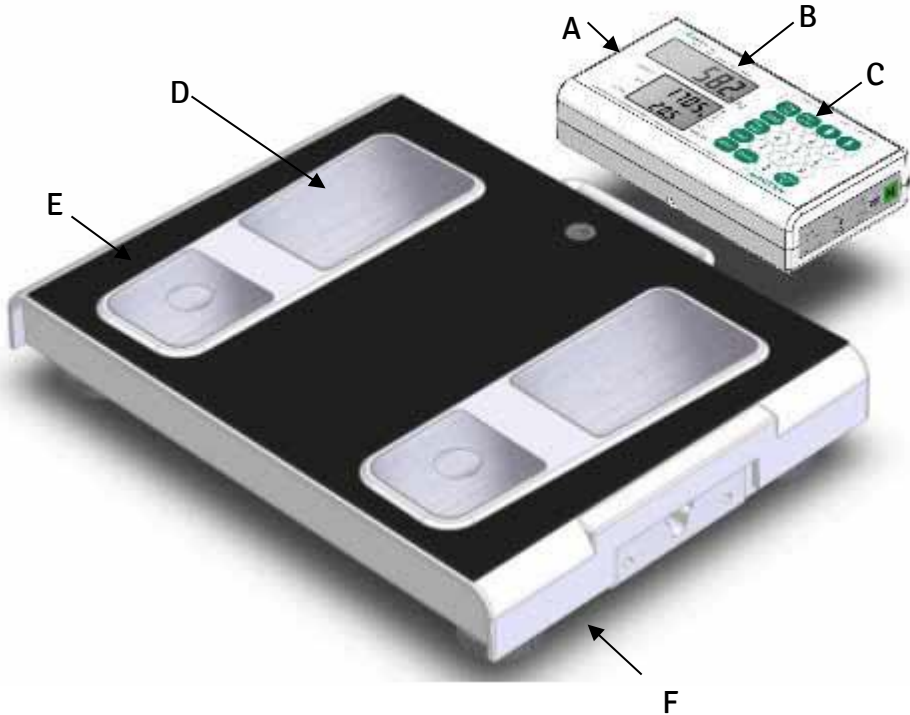

- A: Remote Display
- B: Digital LCD
- C: Control Panel
- D: Pads for feet
- E: Platform
- F: Adjustable feet
- G: Battery in holder

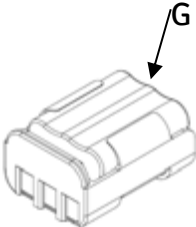

Product Structure: MBF-6010

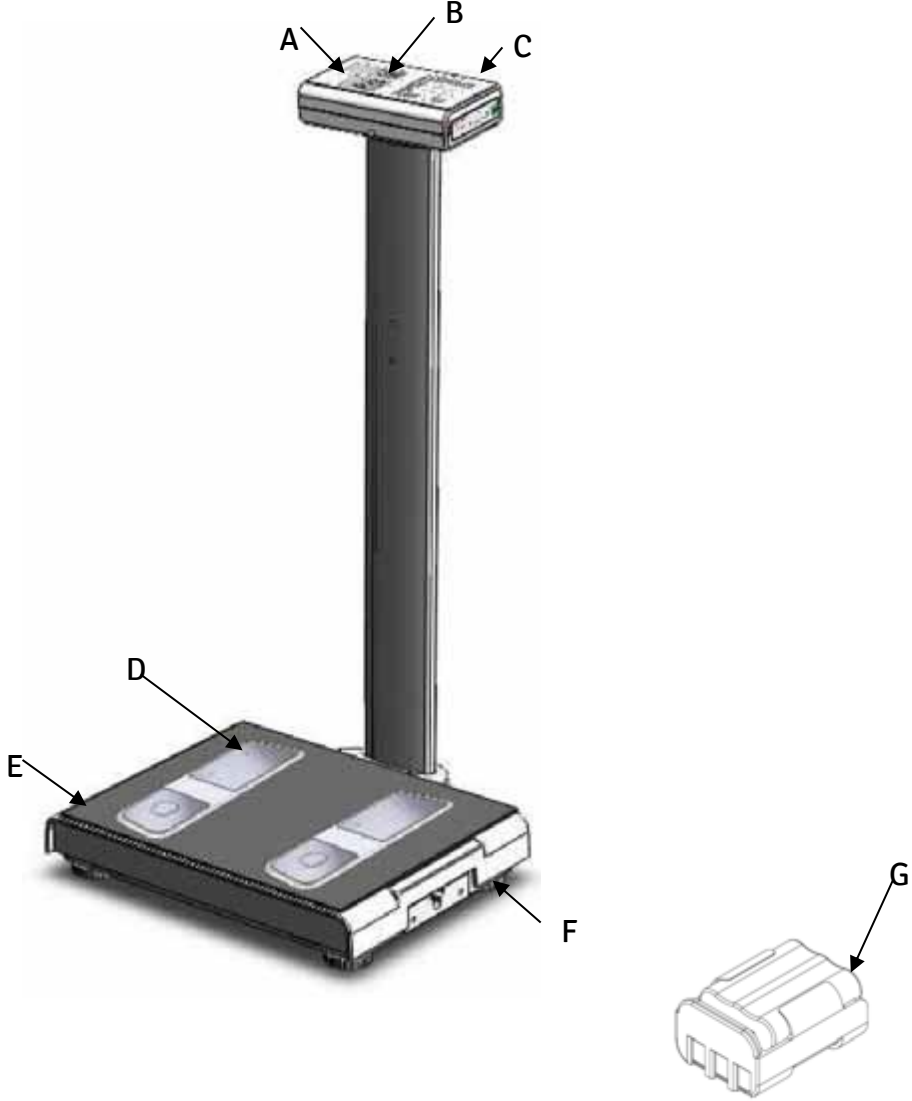

- A: Remote Display
- B: Digital LCD
- C: Control Panel
- D: Pads for feet
- E: Platform
- F: Adjustable feet
- G: Battery in holder

Product Assembly (MBF-6010 only)

Please note: For safety and ease, recommend this scale is assembled by two people.

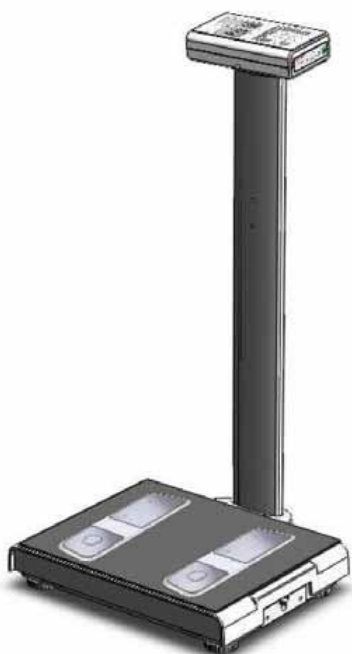

1. Position the column of the MBF-6010 on top of the base, as shown in the graphic on the left, ensuring wires are neatly fed from the base through the inside of the column.

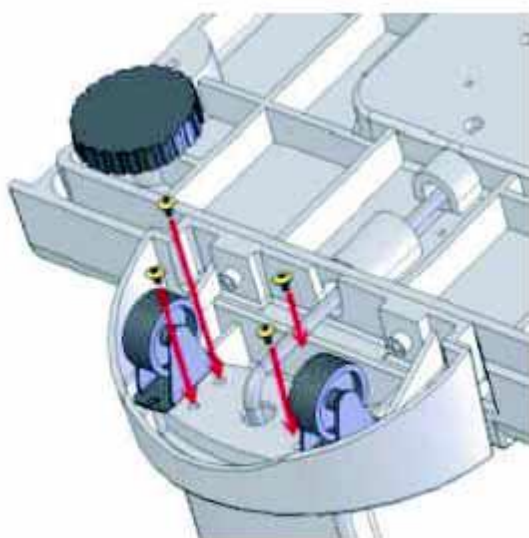

2. Holding both base and column, turn the scale over and secure with screws, as shown in the graphic on the left.

Before Operation

- Install rechargeable battery pack in the battery compartment of the indicator. Alternatively, plug the connector of the AC adaptor into the port on the indicator (shown below).

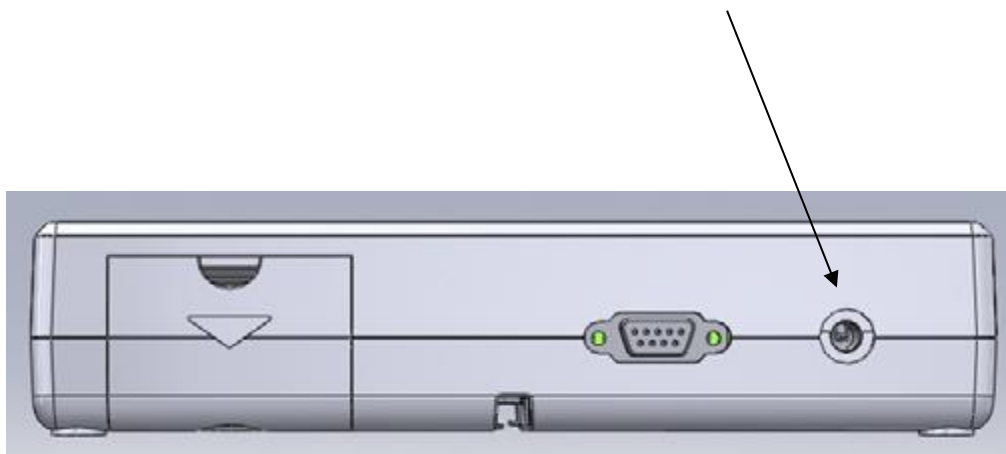

- Attach the printer to the scale using its 9D connector.
- Ensure paper is installed in the printer before switching on the scale.
- The MBF-6010 will require some assembly. The column will need to be screwed to the base: location for screws is on the underside of the base. For assistance, call 01709 364296.

Setting the Date & Time

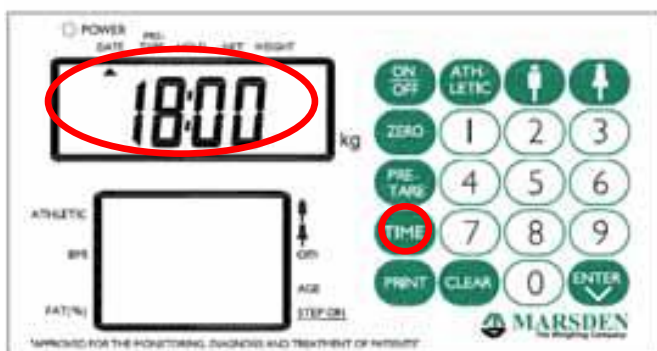
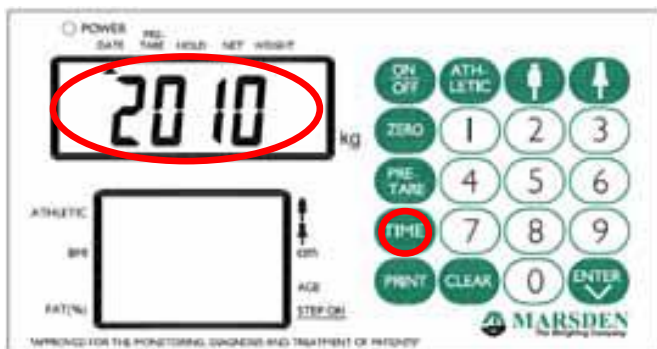

1. Press ON/OFF to switch on the scale.
2. Press TIME, entering the Date/Time setting menu. Year of last date record will be displayed; the 1st digit will flash.

3. Change the flashing digit by using the numerical key on the control panel.
4. Press TIME key to enter Date menu.

5. Change the flashing digits by pressing the numerical key on the control panel.
6. Press TIME, entering Time menu.
7. Change the flashing digit by using the numerical key on the control panel.



Format of display:

- Year: YYYY
- Date: MM.DD
- Time: HR:MIN

8. Press TIME to save the setting.

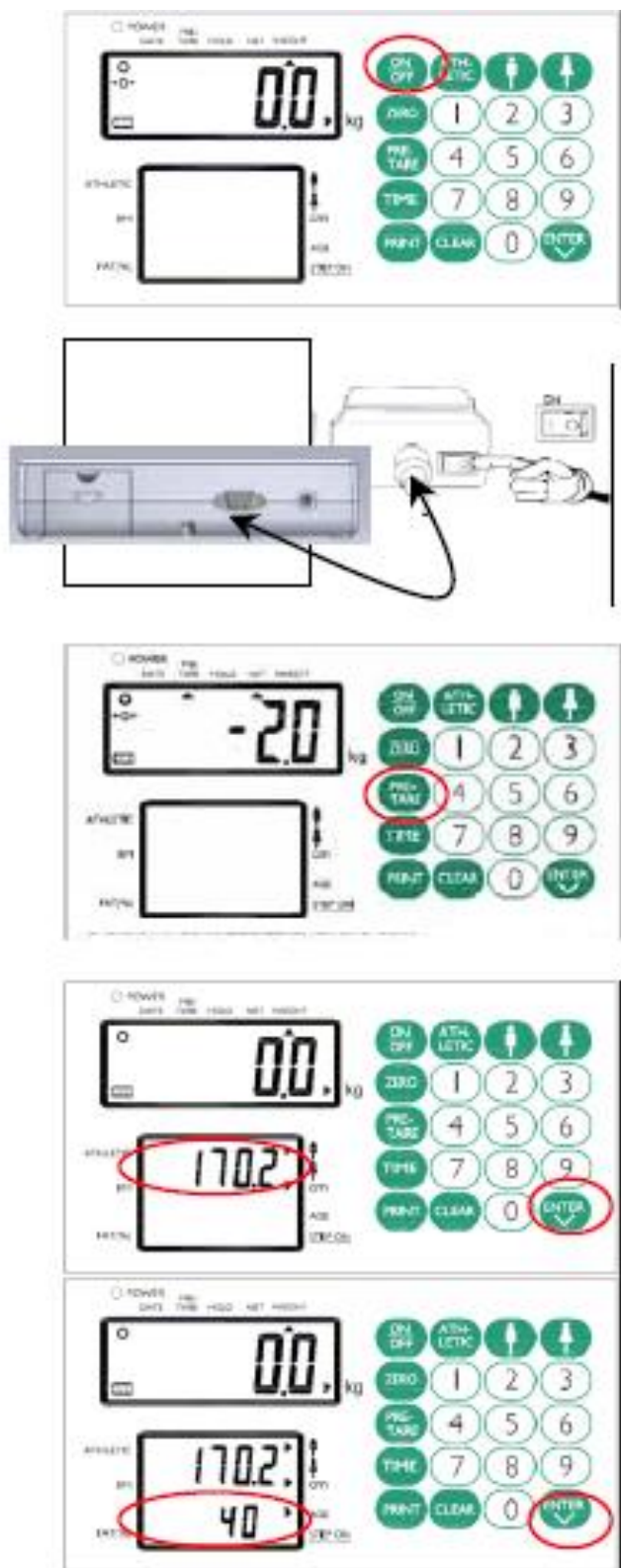
Operation Instructions



1. Press ON/OFF. "0.0" will appear in the top LCD display.
2. Ensure the printer is connected to the back of the indicator. The printer can be switched on by pressing the I/O switch.
3. Press PRE-TARE. Input the weight of your clothes. A minus weight will be displayed in the top LCD display.
4. Select body type by pressing one of the    buttons.
5. Press ENTER, then input your personal data. A height reading will be displayed and the first digit will flash. Input your height using the numerical keys. Alternatively if you have an HM-201D height measure attached this information will be transferred to the scale automatically.
6. Press ENTER. An age will then display below the height, again the first digit will be flashing. Use the numeric keypad to input your age.

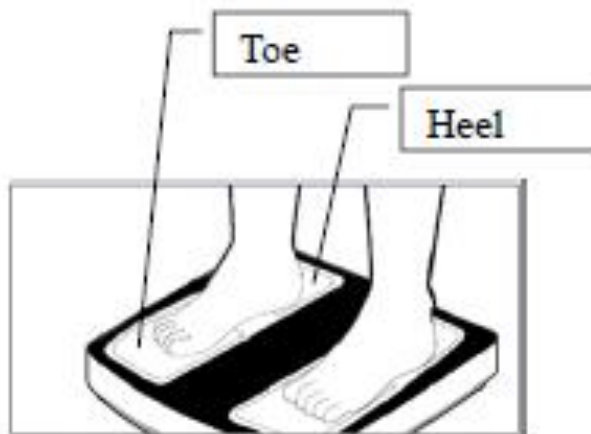

7. Press ENTER, and a flashing arrow will appear in the lower right corner. When this displays you can stand on the scale.

8. Step on the four electrodes of platform with bare feet. Stand straight without bending your knees.

9. Weight will be displayed on the top of the LCD then  will appear with digits running one by one at the bottom for a few seconds.

10. BMI and fat % will then be displayed.

11. To receive a full breakdown of all measurements press PRINT.

12. Press ENTER to switch the lower display from showing BMI and fat %, to height age.

13. Press CLEAR to return to normal weighing mode.

Assembly Instructions: HM-201D

The connection point between the scale's indicator and HM-201D is illustrated below.

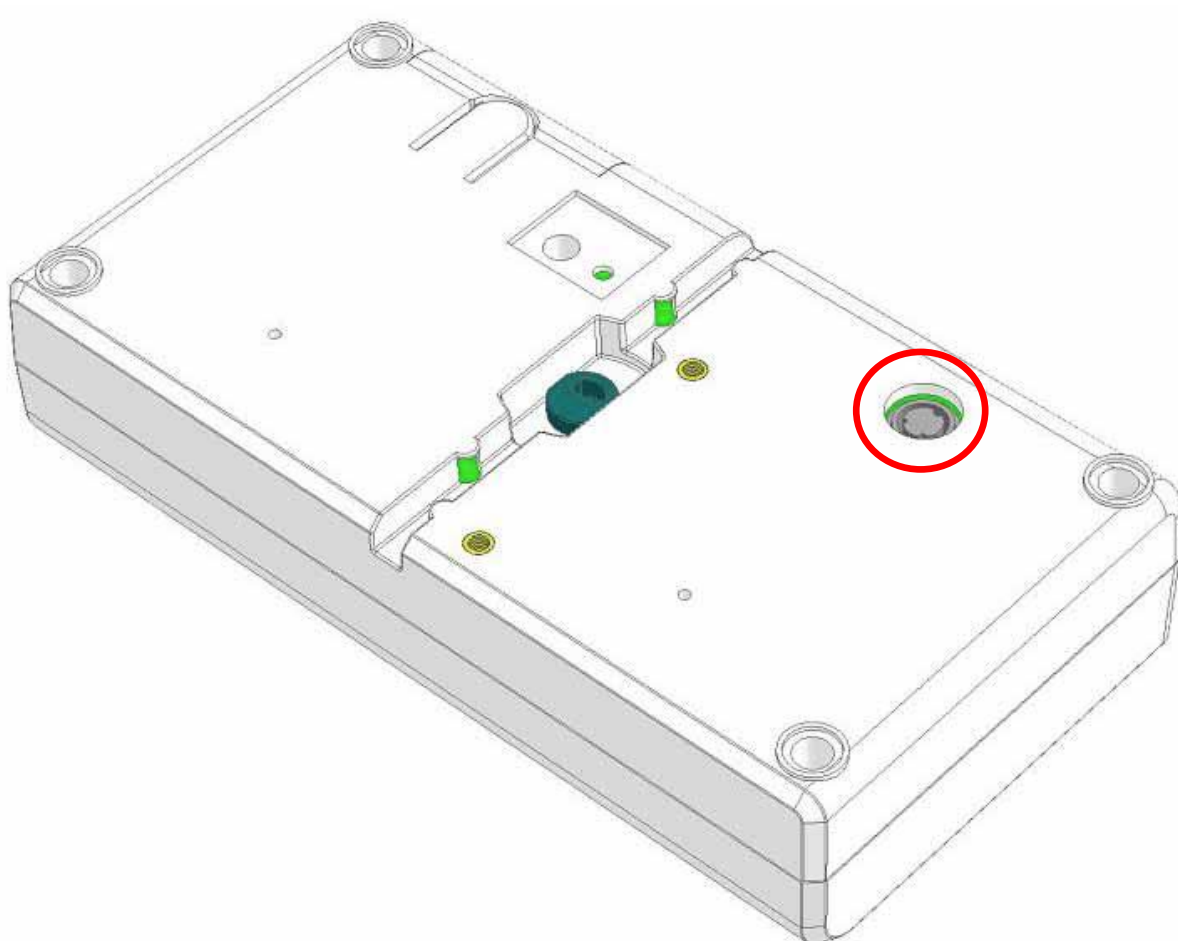

Insert the HM-201D data cable into the socket of the indicator before use.

Replacing the Battery

1. Open the battery housing cover, and take out the battery housing. Reset the rechargeable battery. Make sure the rechargeable battery is properly placed.

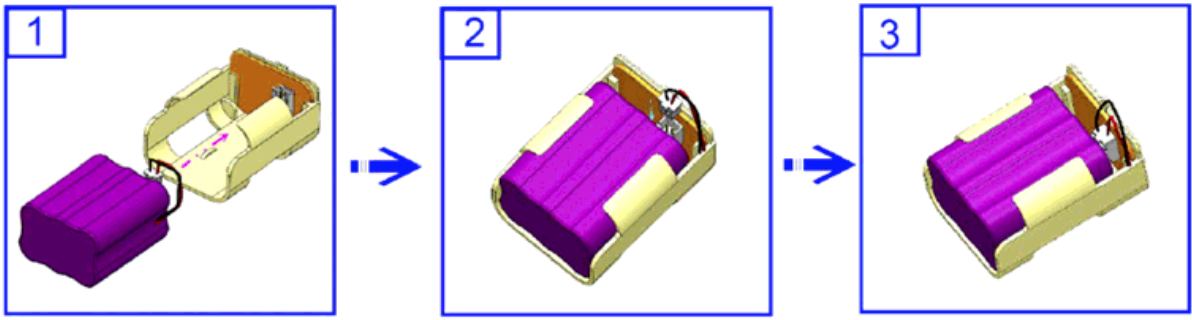

2. Place the battery housing back making sure that the housing pin is connecting to the right point.

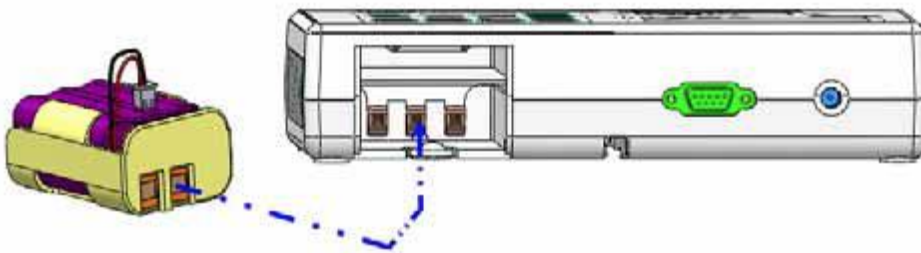

3. Close the battery housing cover.



Print-out Readings Explained

BMI: The most common way of determining whether a person is overweight or not. Calculated by dividing a person's weight by the square of their height. Healthy BMI is typically 18.5-24.9.

Body Fat Percentage: Separates your body composition into two categories - your fat mass and everything else (bones, muscle, hair and water). Healthy Body Fat Percentage for men is 8-20% for men; it's 15-31% for women.

TBW - Total Body Water: This shows how hydrated the body is - which is beneficial for transporting waste, helping organs to function, regulating body temperature and digestion. For men, a healthy Total Body Water is 60-65%; for women it is 45-60%.

BMR - Basal Metabolic Rate: This is the minimum amount of calories that your body needs to function. For men this is typically around 1662 calories; for women, 1393 calories.

FM/FFM - Fat Mass / Fat Free Mass: The total mass of fat in the body - and the Fat Free Mass is the total of everything else. Some fat is essential, to protect vital organs. Aim for around 10-12% (for men) and 20-32% (for women).

BM - Bone Mineral content: This is the measure of bone mineral found in the body. A higher bone mineral content indicates a higher bone density and strength.

MM - Muscle Mass: The weight of muscles in the body. As this increases, the body is able to burn calories and energy faster. This increases your basal metabolic rate (BMR), which helps the body lose weight.

PM - Protein Mass: Protein mass is the total amount of protein in the body.

ECW - Extracellular Water: Extracellular water is the water found outside cells which helps particular tissue to function well. Nutrients and other supplements are served to membrane-bound cells - including sodium, potassium, calcium, chlorides and bicarbonates. ECW makes up 45% of total body water.

ICW - Intracellular Water: ICW is the water usually found inside cells that possesses dissolved ions and some other components that are important in the cellular process. This represents 55% of total body water.

SM - Skeletal Muscle Index: Skeletal muscle is the only type of muscle which actively grows through exercise and nutrition.

VFA level - Visceral Fat Area level: Visceral fat wraps around major organs like the liver, pancreas and kidney.

AGEM: Metabolic Age: The AGEM is your Basal Metabolic Rate compared to the average BMR for your age group. It will thereby estimate your age in years.

Health score: Health score is calculated out of 100 using height, age, weight and gender information - as well as impedance of limbs and trunk.





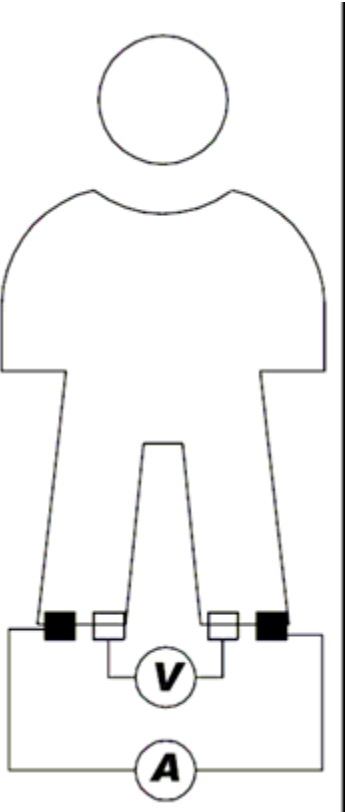

For more information visit www.marsden-weighing.co.uk/blog.

Body Impedance Measurement Methods

In the conventional 4-electrode method, current is supplied from the electrodes at the tips of the toes on both feet, with the voltage measured on the heel. This current flows from one lower limb through the lower abdomen and then into the other lower limb, and the bio electrical impedance (hereinafter, impedance,) thus measured is the impedance between the two feet. For reference, the impedance measurement methods for the legs are shown in the diagram below.

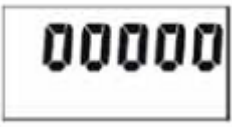

Error Messages

Error Message	Reason	Action
	Low Battery: This warning shows that battery power is too low for the scale to be used.	Please plug in the adaptor to charge or operate the scale.
	Overload: The total load exceeds the maximum capacity of the scale.	Please reduce the load on the scale and try again.
	Counting error (too high): Indicates that the signal from the loadcell is too high.	This error is normally caused by a serious fault such as a faulty loadcell or wiring. Please contact Marsden or your local service representative.
	Counting error (too low): Indicates that the signal from the loadcell is too low.	This error is normally caused by a serious fault on the scales such as a faulty loadcell or wiring. Please contact the local service representative.
	Zero count over calibration zero range +10% while power on.	Please re-calibrate the scale.
	Zero count under calibration range -10% while power on.	Please re-calibrate the scale.
	EEPROM Error: Indicates that there is a fault with the scale's software.	This error is normally caused by a serious fault on the scales such as a faulty loadcell or wiring. Please contact the local service representative.



EU Directive 2012/19/EU restricts the use of the six substances below in the manufacture of specified types of electrical equipment.

- The product does not contain any of the restricted substances in concentrations and applications banned by the directive;
- and for components, the product is capable of being worked on at higher temperatures required by lead-free soldering.

The restricted substances and maximum allowed concentrations in the homogenous material are, by weight:

Substance	Concentration
Lead	0.1%
Mercury	0.1%
PBB (Polybrominated Biphenyls)	0.1%
PBDE (Polybrominated Diphenyl Ethers)	0.1%
Hexavalent Chromium	0.1%
Cadmium	0.01%

EMC Guidance and Manufacturer's Declaration

Guidance and manufacturer's declaration-electromagnetic emissions		
The MEDICAL SCALE MBF6000/MBF6010 is intended for use in the electromagnetic environment specified below. The customer or the user of the MEDICAL SCALE MBF6000/MBF6010 should assure that it is used in such an environment.		
Emission test	Compliance	Electromagnetic environment-guidance
RF emissions CISPR 11	Group 1	The MEDICAL SCALE MBF6000/MBF6010 uses RF energy only for its internal function. Therefore, its RF emissions are very low and are not likely to cause any interference in nearby electronic equipment.
RF emissions CISPR 11	Class B	The MEDICAL SCALE MBF6000/MBF6010 is suitable for use in all establishments, including domestic establishments and those directly connected to the public low-voltage power supply network that supplies buildings used for domestic purposes.
Harmonic emissions IEC 61000-3-2	Class A	
Voltage fluctuations /flicker emissions IEC 61000-3-3	Compliance	

Guidance and manufacturer's declaration-electromagnetic immunity			
The MEDICAL SCALE MBF6000/MBF6010 is intended for use in the electromagnetic environment specified below. The customer or the user of the MEDICAL SCALE MBF6000/MBF6010 should assure that it is used in such an environment.			
Immunity test	IEC 60601 test level	Compliance level	Electromagnetic environment-guidance
Electrostatic discharge(ESD) IEC 61000-4-2	± 6 kV contact ± 8 kV air	± 6 kV contact ± 8 kV air	Floors should be wood, concrete or ceramic tile. If floors are covered with synthetic material, the relative humidity should be at least 30%
Electrical fast transient/burst IEC 61000-4-4	± 2kV for power supply lines + 1kV for input/output lines	± 2kV for power supply lines Not applicable	Mains power quality should be that of a typical commercial or hospital environment.
Surge IEC 61000-4-5	± 1kV line(s) to line(s) ± 2kV line(s) to earth	± 1kV differential mode Not applicable	Mains power quality should be that of a typical commercial or hospital environment.

Voltage Dips, short interruptions and voltage variations on power supply input lines IEC 61000-4-11	<5% UT(>95% dip in UT) for 0,5 cycle 40% UT(60% dip in UT) for 5 cycles 70% UT(30% dip in UT) for 25 cycles <5% UT(>95% dip in UT) for 5 s	<5% UT(>95% dip in UT) for 0,5 cycle 40% UT(60% dip in UT) for 5 cycles 70% UT(30% dip in UT) for 25 cycles <5% UT(>95% dip in UT) for 5 s	Mains power quality should be that of a typical commercial or hospital environment. If the user of the MEDICAL SCALE MBF6000/MBF6010 requires continued operation during power mains interruptions, it is recommended that the MEDICAL SCALE MBF6000/MBF6010 be powered from an uninterruptible power supply or a battery.
Power frequency(50/60 Hz) magnetic field IEC 61000-4-8	3 A/m	3 A/m	The MEDICAL SCALE MBF6000/MBF6010 power frequency magnetic fields should be at levels characteristic of a typical location in a typical commercial or hospital environment.
NOTE UT is the a.c. mains voltage prior to application of the test level.			

Guidance and manufacturer's declaration-electromagnetic immunity

The MEDICAL SCALE MBF6000/MBF6010 is intended for use in the electromagnetic environment specified below. The customer or the user of the MEDICAL SCALE MBF6000/MBF6010 should assure that is used in such and environment.

Immunity test	IEC 60601 test level	Compliance level	Electromagnetic environment-guidance
Conducted RF IEC 61000-4-6	3 Vrms 150 KHz to 80 MHz	3 Vrms	<p>Portable and mobile RF communications equipment should be used no closer to any part of the MEDICAL SCALE MBF6000/MBF6010 including cables, than the recommended separation distance calculated from the equation applicable to the frequency of the transmitter.</p> <p>Recommended separation distance: $d = 1,2 \sqrt{P}$ $d = 1,2 \sqrt{P}$ 80MHz to 800 MHz $d = 2,3 \sqrt{P}$ 800MHz to 2,5 GHz</p> <p>Where P is the maximum output power rating of the transmitter in watts (W) according to the transmitter manufacturer and d is the recommended separation distance in metres (m).</p> <p>Field strengths from fixed RF transmitters, as determined by an electromagnetic site survey^a, should be less than the compliance level in each frequency range^b.</p>

Radiated RF IEC 61000-4-3	3 V/m 80MHz to 2,5 GHz	3 V/m	Interference may occur in the vicinity of equipment marked with the following symbol: 
---------------------------	------------------------	-------	--

NOTE1 At 80 MHz and 800 MHz, the higher frequency range applies.

NOTE2 . These guidelines may not apply in all situations. Electromagnetic propagation is affected by absorption and reflection from structures, objects/people.

- a Field strengths from fixed transmitters, such as base stations for radio (cellular/cordless) telephones and land mobile radios, amateur radio, AM and FM radio broadcast and TV broadcast cannot be predicted theoretically with accuracy. To assess the electromagnetic environment due to fixed RF transmitters, an electromagnetic site survey should be considered. If the measured field strength in the location in which the MEDICAL SCALE MBF6000/MBF6010 is used exceeds the applicable RF compliance level above, the MEDICAL SCALE MBF6000/MBF6010 should be observed to verify normal operation. If abnormal performance is observed, additional measures may be necessary, such as re-orienting or relocating the MEDICAL SCALE MBF6000/MBF6010.
- b Over frequency range 150 kHz to 80 MHz, field strengths should be less than 3 V/m.

Recommended separation distance between portable and mobile RF communications equipment and the MEDICAL SCALE

The MEDICAL SCALE MBF6000/MBF6010 is intended for use in an electromagnetic environment in which radiated RF disturbances are controlled. The customer or the user of the MEDICAL SCALE MBF6000/MBF6010 can help prevent electromagnetic interference by maintaining a minimum distance between portable and mobile RF communications equipment (transmitters) and the MEDICAL SCALE MBF6000/MBF6010 as recommended below, according to the maximum output power of the communications equipment.

Rated maximum output power of transmitter W	Separation distance according to frequency of transmitter m		
	150 kHz to 80 MHz $d = 1,2\sqrt{P}$	80 MHz to 800 MHz $d = 1,2\sqrt{P}$	800 MHz to 2,5 GHz $d = 2,3\sqrt{P}$
0,01	0,12	0,12	0,23
0,1	0,38	0,38	0,73
1	1,2	1,2	2,3
10	3,8	3,8	7,3
100	12	12	23



For transmitters rated at a maximum output power not listed above, the recommended separation distance d in metres (m) can be estimated using the equation applicable to the frequency of the transmitter, where p is the maximum output power rating of the transmitter in watts (W) according to the transmitter manufacturer.

NOTE1 At 80 MHz and 800 MHz, the separation distance for the higher frequency range applies.

NOTE2 These guidelines may not apply in all situations. Electromagnetic propagation is affected by absorption and reflection from structures, objects and people.

Manufacturer's Declaration of Conformity

This product has been manufactured in accordance with the harmonized European standards, following the provisions of the below stated directives:

	93/42/EEC as amended by 2007/47/EC Medical Device Directive
	2011/65/EU Non-automatic Weighing Instruments Directive

Please see separate document showing on sticker of device for above CE marking.

Authorized EU Representative:



Wellkang Ltd
Suite B, 29 Harley Street
LONDON, W1G 9QR, U.K.

Manufactured by:



Charder Electronic Co., Ltd.
No.103, Guozhong Rd., Dali Dist.,
Taichung City 412, Taiwan (R.O.C.)

MARSDEN

Tel: 01709 364296 / 0800 169 2775

Fax: 01709 364293

E-mail: sales@marsdengroup.co.uk

Manufacturing and Distribution:

Unit 7, Centurion Business Park,

Coggin Mill Way,

Rotherham,

S60 1FB

Head Office:

Unit 1, Genesis Business Park,

Sheffield Road,

Rotherham

S60 1DX

www.marsden-weighing.co.uk