

# MARSDEN

## Marsden M-700 User Manual



Please take time to read these instructions before starting to use the scale.

## Contents

Introduction .....	2
Product Specification .....	2
Safety Instructions .....	3
Cleaning.....	3
Maintenance .....	3
Disposing of the Scale .....	3
Intended Use.....	3
Explanation of Graphic Symbols.....	4
Power Supply and Low Battery.....	5
Installing and Replacing the Battery Pack .....	5
Switching on the Scale.....	6
Switching off the Scale.....	7
Setting the Scale to Zero .....	7
Hold Function.....	8
Setting Auto Hold Function (Optional).....	9
Body Mass Index (BMI) Function.....	9
Tare and Pre-Set Tare Functions .....	10
Setting the Date .....	11
Using the Scale with a Printer.....	12
Connecting the TP-2100 Thermal Printer .....	12
Using the Scale with Wi-Fi/Bluetooth.....	13
Using the Baby Bowl.....	14
EMC Guidance and Manufacturer's Declaration.....	15
Error Messages.....	17

## Introduction

Thank you for purchasing a Marsden professional medical scale. This is a precision Class III weighing instrument and considerate use will result in many years of accurate weighing. The scale has a maximum load capacity of 150kg which must not be exceeded.

## Product Specification

Model	M-700
Accuracy Class	Class III
Capacity/Division (Base/seat)	150kg x 20g <60kg> 50g
Capacity/Division (Baby bowl)	60kg x 20g
Units of Measure	Kg
Function Keys	ON/OFF, ZERO, HOLD, TARE, BMI, UNIT, PRINT, 0-9
Stabilisation Time	1-2 Seconds
Operating Temperature	0 to 40° C
Power Supply	Rechargeable battery pack 6 x AA batteries* Mains Adaptor
Adaptor Type	2UE24WV-120100SPA & UE24WB-120100SPA
Indicator Display	2.5 cm LCD display with 5 active digits
Base Dimensions	700mm x 600mm x 45mm
Warranty	8 years

## Safety Instructions

Before putting the device into use, please read with care the information given in this user manual, which contains important instructions for proper installation, use and maintenance of the device.

Marsden and/or the manufacturer shall not be liable for damages arising from failure to heed the following instructions:

- When using electrical components under increased safety requirements, always comply with appropriate regulations.
- Inappropriate installation/use will render the warranty null and void.
- Ensure the voltage marked on the power supply unit matches your mains supply.
- This device is designed for use indoors only.
- Observe the permissible ambient temperatures for use.
- The device meets the requirements for electromagnetic compatibility. Do not exceed the maximum values specified in the applicable standards.
- Batteries should be kept away from small children. If swallowed, promptly seek urgent medical assistance.

If you have any problems with this scale, please contact Marsden/your local dealer/your service partner.

If a serious incident occurs in relation to this device, it should be reported to the manufacturer and the competent authority of the Member State in which the user and/or patient is established.

## Cleaning

- We recommend using alcohol-based wipes or similar when cleaning the scale.
- Please do not use corrosive liquids, large amounts of water or high-pressure washers.
- Always disconnect the scale from the mains power supply before cleaning.

## Maintenance

- The scale does not require any routine maintenance. However, we recommend checking the scale's accuracy at regular intervals. If any inaccuracies occur, please contact your local dealer or service partner.
- If you are in the UK, service contracts are available from Marsden to keep your scale accurate and reliable for longer. Call 01709 364296 for more information.















## Disposing of the Scale

- This product should not be treated as regular household waste but should be handed in to an electrical/electronic equipment recycling centre.
- You can obtain further details from your local council, your municipal waste disposal company or from where you purchased the product.
- Alternatively, you can return this product to Marsden – we will recycle this free of charge,

## Intended Use

- This scale is intended for use to determine the weight of patients, supported by professional personnel and in rooms intended for carrying out healthcare. The weighing value can be read after a stable weighing value has been obtained. Before use, the scale must be checked by an authorised person to ensure it's in a suitable condition.
- Device is intended to measure one subject at a time.

## Explanation of Graphic Symbols

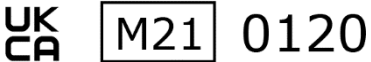
	Caution, consult accompanying documents before use		Separate collection for waste of electrical and electronic equipment, in accordance with Directive 2002/96/EC
	Manufacturer of medical device		Manufacturing year of medical device
	Carefully read user manual before installation and usage, and follow instructions for use.		Medical electrical equipment with Type B applied part
	Device catalogue number		Authorized representative in the European Community
	Manufacturer's batch or lot number		Device is a medical device
	Serial number		Unique Device Identifier
		Device conforms to 93/42/EEC as amended by 2007/47/EC Medical Device Directive. Four digit number refers to Notified Body.	
		Device complies with International Organization of Legal Metrology (Class III) requirements (verified models only)	
		<p>Device complies with EC directives (verified models only)</p> <p><b>M:</b> Conformity label in compliance with Directive 2014/31/EU for non-automatic weighing instruments</p> <p><b>19:</b> Year in which conformity verification was performed and the CE label was applied. (ex: 19=2019)</p> <p><b>0122:</b> Refers to Notified Body for metrology</p>	
		<p>Device complies with UK Regulation.</p> <p><b>M:</b> Non-Automatic Weighing Instruments Regulations 2016.</p> <p><b>21:</b> Year in which conformity verification was performed and the CE label was applied. (ex: 21=2021)</p> <p><b>0120:</b> Refers to the Approved Body for metrology</p>	

## Power Supply and Low Battery

The indicator uses a rechargeable battery pack, a non-rechargeable battery pack, or can be powered from the mains via the AC adaptor.

Make sure the battery pack is installed in the battery box of the indicator. Alternatively, plug the AC adaptor (12V 2A) into the port on the side of the indicator.

## Installing and Replacing the Battery Pack

1. Take out the battery housing.
2. The rechargeable battery pack will slide into, or out of, the housing.



3. Check that the housing pin is connecting to the right point inside the indicator.

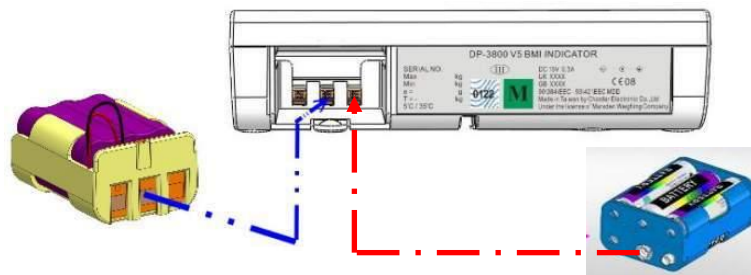

4. Place the housing back in the back of the indicator and close the battery housing cover.

## Switching on the Scale

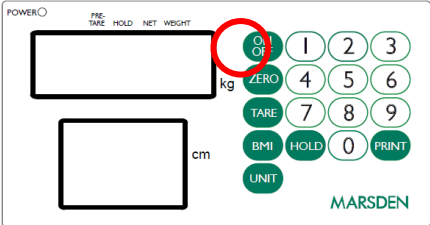
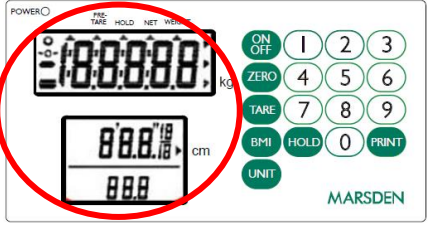
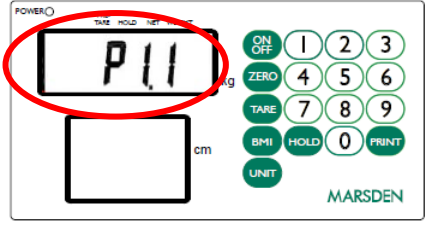
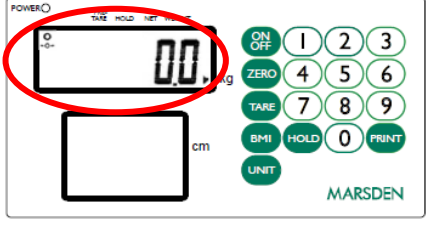
 <p>The image shows the control panel of a Marsden scale. The top display is blank. The bottom display shows 'cm'. The 'ON/OFF' button is circled in red. The keypad includes buttons for 1-9, 0, PRINT, ZERO, TARE, BMI, HOLD, and UNIT. The brand name 'MARSDEN' is visible at the bottom.</p>	<p>Press the ON/OFF button firmly.</p>
 <p>The top display shows a test pattern of eight segments: '0', '1', '2', '3', '4', '5', '6', '7', '8', '9'. The bottom display shows 'cm' and '888'. The 'ON/OFF' button is circled in red.</p>	<p>The scale will first test all of the display segments.</p>
 <p>The top display shows 'P11'. The bottom display shows 'cm'. The 'ON/OFF' button is circled in red.</p>	<p>The scale will now show its current software version number.</p>
 <p>The top display shows '00.0'. The bottom display shows 'cm'. The 'ON/OFF' button is circled in red.</p>	<p>The scale will now go into weighing mode and should show 0.0kg on the display.</p>

## Switching off the Scale

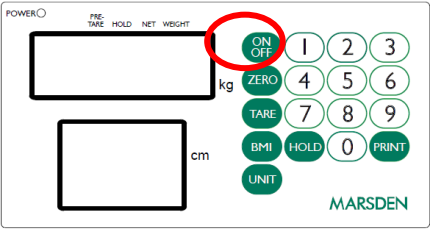
	<p>Press the ON/OFF button when the scale is turned on. The scale will now power down.</p>
---	--

## Setting the Scale to Zero

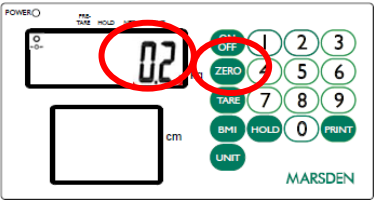
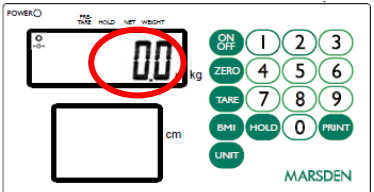

	<p>If for any reason the scale shows a reading other than 0.0kg it can be reset to zero. Press the ZERO key once.</p>
	<p>The scale will return to 0.0kg.</p>

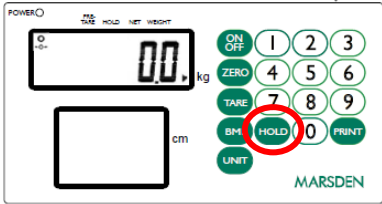
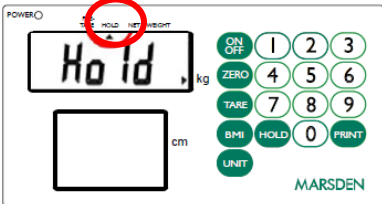
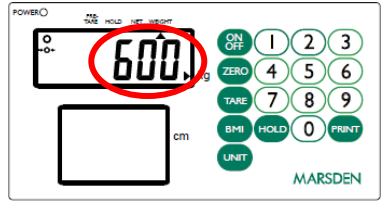
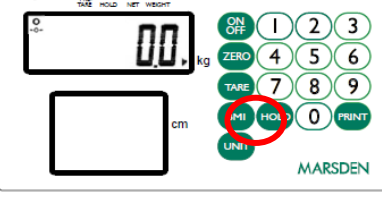
## Hold Function

 <p>The image shows the control panel of a Marsden scale. The digital display shows '00.0' kg. The 'HOLD' button on the keypad is circled in red. The keypad includes buttons for ON/OFF, ZERO, TARE, BMI, UNIT, and a numeric keypad (0-9). The brand name 'MARS DEN' is visible at the bottom.</p>	<p>Press the HOLD button once.</p>
 <p>The digital display now shows 'Hold'. The 'HOLD' button on the keypad is circled in red. The rest of the control panel remains the same as in the previous step.</p>	<p>Allow the patient to be wheeled onto the scale.</p>
 <p>The digital display now shows '600.0' kg. The display is circled in red. The 'HOLD' button on the keypad is also circled in red. The rest of the control panel remains the same.</p>	<p>After a few seconds the scale will lock on the person's weight. When the patient leaves the scale, the weight will remain on the display.</p>
 <p>The digital display has returned to '00.0' kg. The 'HOLD' button on the keypad is circled in red. The rest of the control panel remains the same.</p>	<p>Press HOLD again to disable the Hold function and return the scale to 0.0kg.</p>

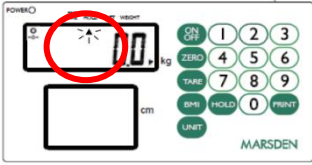

## Setting Auto Hold Function (Optional)

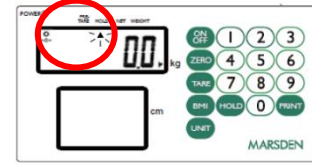
	<p>The display will have a flashing triangle mark under the HOLD button once the scale is turned on.</p>
	<p>Allow the patient to be wheeled onto the scale. The scale will automatically lock on the patient's weight to complete the hold function. The triangle mark remains on the display during this period.</p>
	<p>When the patient leaves the scale and the scale returns to 0.0kg., the triangle mark will begin to flash again.</p>

## Body Mass Index (BMI) Function

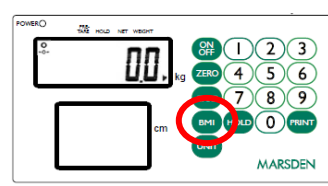
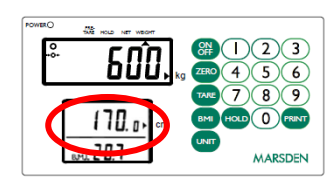
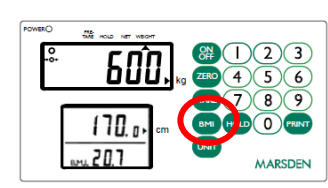
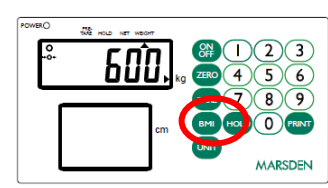
	<p>In normal mode, press the BMI key to enter into BMI mode.</p>
	<p>The display will show the last height entered and the extreme left digit will flash. Enter the height by using the numeric keys. Press the ZERO key to confirm the height. (NB: There will always be an active flashing digit in the height display, unless HOLD is pressed).</p>
	<p>Weigh the patient as normal. The display will show the weight, height and BMI value. At this time, the weight and height can be freely changed, and the BMI value will be automatically calculated according to the changed weight and height.</p>
	<p>Press the BMI key to return to normal weighing mode.</p>



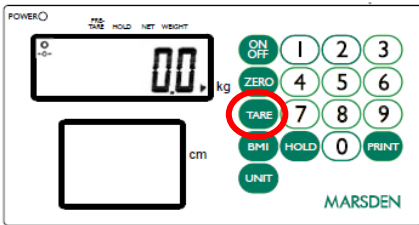
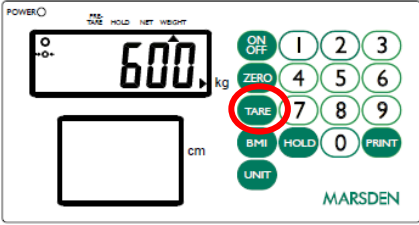
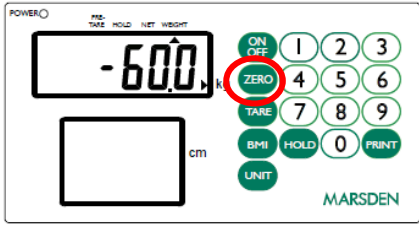
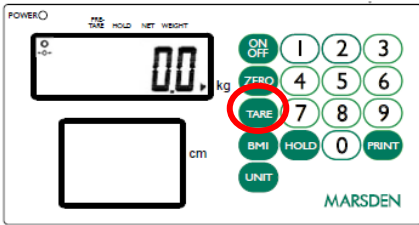

## Tare and Pre-Set Tare Functions

 <p>The image shows a Marsden scale display with '0.00' and 'kg' on the screen. The TARE key on the keypad is circled in red. The keypad includes keys for ON/OFF, ZERO, TARE, BMI, HOLD, UNIT, and numeric keys 1-9, 0, and PRINT.</p>	<p>Press the TARE key for three seconds to enter Preset Tare setting mode.</p>
 <p>The image shows the scale display with '600' and 'kg' on the screen. The TARE key on the keypad is circled in red.</p>	<p>The display will show the last preset tare entered and the extreme left digit will flash. Enter the preset tare value by using the numeric keys, then press the TARE key again to confirm the value.</p>
 <p>The image shows the scale display with '-600' and 'kg' on the screen. The ZERO key on the keypad is circled in red.</p>	<p>Press the ZERO key to return to normal weighing mode.</p>
 <p>The image shows the scale display with '0.00' and 'kg' on the screen. The TARE key on the keypad is circled in red.</p>	<p>To use the Tare function, add the item you wish to tare off to the scale, and press the TARE key. The display will show zero, and then a minus number when the item is removed from the scale.</p>

## Setting the Date

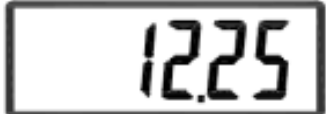
Press HOLD for three seconds to access the time setting mode. The time period digit that is flashing can be changed by using the numeric keys. The time period to be edited is selected by pressing HOLD.

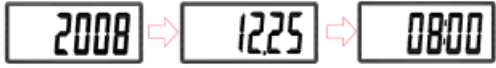
E.g., To input 25 December 2008, 8:00 a.m.:

	Enter the year. Press HOLD to confirm and access the date editing field.
	Enter the date. E.g. "12.25" for December 25th. Press HOLD to confirm and access the time clock editing field.
	Enter the time (24 hour clock only).
	Press HOLD and the display shows: YYYY→MM.DD→HH:SS
	Press HOLD to return to normal weighing mode.

## Using the Scale with a Printer

An optional Marsden external printer (model TP-2100) is available for all models. With the printer fitted, the patient's weight, height, and BMI result can be printed.

Once the person has been weighed and their BMI calculated, simply press PRINT to produce the following ticket:

<b>GROSS WEIGHT</b>	<b>60.00kg</b>
<b>TARE WEIGHT</b>	<b>30.00kg</b>
<b>NET WEIGHT</b>	<b>30.00kg</b>
<b>PATIENT HEIGHT</b>	<b>100.0cm</b>
<b>PATIENT B.M.I</b>	<b>37.5</b>
<b>29/12/2008 17:00</b>	

## Connecting the TP-2100 Thermal Printer



Plug the cable to the printer, and then connect its 9D connector to the indicator.

## Using the Scale with Wi-Fi/Bluetooth

If your scale has device connectivity, the universal wireless symbol will be on the main indicator display. If your scale does not have Wi-Fi or Bluetooth connectivity, we do not supply the software to capture the data from the weighing scale. We do however provide the protocols for you to implement the devices into your own software.

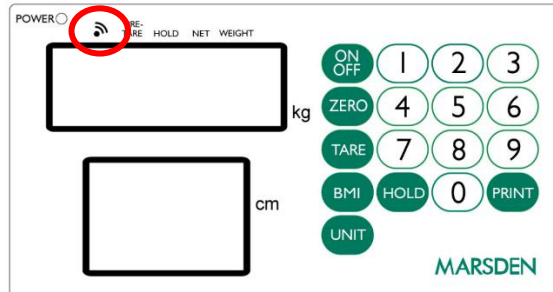

### Bluetooth Connection

	Long press ZERO for three seconds to enter the Setting mode and then display the A-OFF menu.
	Press TARE twice, and then press HOLD once to enter the Bluetooth setting mode.
	Using the HOLD button, select "ON" (enable) or "OFF" (disable). Press TARE to confirm the setting. <b>Note: Disabling the Bluetooth function when not in use will reduce battery power consumption.</b>
	Display the "bluEt" menu. Press TARE once.
	Press HOLD to return to normal mode. Search for the scale in your computer or device's Bluetooth settings (procedure may vary depending on device or system) The scale will appear on the Bluetooth device list as " <b>MARSDEN BT</b> ". Connect your device to "MARSDEN BT", and the scale is ready to transmit data wirelessly via Bluetooth.

### Wi-Fi Connection

	Turn the scale on and press the TARE key for 3 seconds to enter into settings. Press the HOLD key several times until the display shows the information on the left. When the display shows the symbols shown on the left, press the TARE key to see the status (ON/OFF). If the display shows OFF, press the HOLD key once and it will change to ON. Then press the TARE key to confirm the setting.
	Press the HOLD key several times until END shows on the display. When END is on the display, press the TARE keypad to enter normal weighing mode.
	If the highlighted triangular sign is not visible, Wi-Fi is turned off. If the triangle is solid, the device is connecting. When the triangle is blinking, the device is successfully connected.

## Using the Baby Bowl

The M-700 has a 60kg-capacity baby bowl attachment.

The baby bowl can be removed when the seat is being used, using the locking latches on either side.



- ⚠ Always ensure the scale is switched off before removing or adding the baby bowl.
- ⚠ When attaching the baby bowl, always ensure both latches are engaged and that the bowl is attached firmly to the scale.
- ⚠ If the baby bowl attachment becomes loose and the latches do not hold it firmly in place, do not use the scale. Contact your service provider.
- ⚠ Never leave a baby unsupervised in the baby bowl.

We recommend that the bolts holding the latches are checked for tightness during service visits. We advise that servicing intervals are no longer than every 12 months.

## EMC Guidance and Manufacturer's Declaration

Guidance and manufacturer's declaration – electromagnetic emissions.

The M-700 is intended for use in the electromagnetic environment specified below. The customer or user of this scale should ensure that it is used in such environment.

Emission Test	Compliance	Electromagnetic environment-guidance
RF emissions CISPR 11	Group 1	This scale uses RF energy only for its internal function. Therefore, its RF emissions are very low and not likely to cause any interference in nearby electronic equipment.
RF emissions CISPR 11	Class B	This scale is suitable for use in all establishments, including domestic establishments and those directly connected to the public low-voltage power supply network that supplies buildings used for domestic purposes.
Harmonic emissions IEC 61000-3-2	Class A	
Voltage fluctuations/flicker emissions IEC 61000-3-3	Compliance	

## Guidance and manufacturer's declaration – electromagnetic immunity.

The M-700 is intended for use in the electromagnetic environment specified below. The customer or the user of this scale should ensure that it is used in such an environment.

Immunity Test	IEC 60601 Test Level	Compliance Level	Electromagnetic Environment Guidance
Electrostatic discharge (ESD) IEC 61000-4-2	± 6 kV contact ± 8 kV air	± 6 kV contact ± 8 kV air	Floors should be wood, cement or ceramic tile. If floors are covered with synthetic material, the relative humidity should be at least 30%.
Electrical fast transient/burst IEC 61000-4-4	± 2 kV for power supply lines +1 kV for input/output lines	± 2 kV for power supply lines not applicable	Mains power quality should be that of a typical commercial or hospital environment.
Surge IEC 61000-4-5	± 1kV line(s) to line(s) ± 2 kV line(s) to earth	± 1 kV differential mode not applicable	Mains power quality should be that of a typical commercial or hospital environment.
Voltage Dips, short interruptions and voltage variations on power supply input lines IEC 61000-4-11	<5% UT (>95% dip in UT) for 0.5 cycle 40% UT (60% dip in UT) for 5 cycles 70% UT (30% dip in UT) for 25 cycles <5% UT (>95% dip in UT) for 5s	<5% UT (95% dip in UT) for 0.5 cycle 40% UT (60% dip in UT) for 5 cycles 70% UT (30% dip in UT) for 25 cycles <5% UT (>95% dip in UT) for 5s	Mains power quality should be that of a typical commercial or hospital environment. If the user of this scale requires continued operation during power mains interruptions, it is recommended that this scale is powered from an uninterruptible power supply or a battery.
Power frequency (50/60 Hz) magnetic field IEC 61000-4-8	3 A/m	3 A/m	The scale's power frequency magnetic fields should be at levels characteristic of a typical location in a typical commercial or hospital environment.

Note UT is the A.C mains voltage prior to application of the test level.

## Guidance and manufacturer's declaration – electromagnetic immunity.

This scale is intended for use in the electromagnetic environment specified below. The customer or the user of the scale should ensure that it is used in such an environment.

Immunity Test	IEC 60601 test level	Compliance level	Electromagnetic environment-guidance
Conducted RF IEC 61000-4-6	3 Vrms 150 KHz to 80 MHz	3 Vrms	Portable and mobile RF communications equipment should be used no closer to any part of the scale including cables, than the recommended separation distance calculated from the equation applicable to the frequency of the transmitter.

Radiated RF IEC 61000-4-3	3 V/m 80 MHz to 2,5 GHz	3 V/m	<p><b>Recommended separation distance:</b>  <math>d = 1,2 \sqrt{P}</math>  <math>d = 1,2 \sqrt{P}</math> 80MHz to 800 MHz  <math>d = 2,3 \sqrt{P}</math> 800MHz to 2,5 GHz</p> <p>Where <math>P</math> is the maximum output power rating of the transmitter in watts (w) according to the transmitter manufacturer and <math>d</math> is the recommended separation distance in meters (m).  Field strengths from fixed RF transmitters, as determined by an electromagnetic site survey, should be less than the compliance level in each frequency range.</p> <p>Interference may occur in the vicinity of equipment marked with the following symbol:</p> 
<p>NOTE1 At 80 MHz and 800 MHz, the higher frequency range applies.  NOTE2 These guidelines may not apply in all situations. Electromagnetic propagation is affected by absorption and reflection from structures, objects and people.</p>			
<p>A) Field strengths from fixed transmitters, such as base stations for radio (cellular/cordless) telephones and land mobile radios, amateur radio, AM and FM radio broadcast and TV broadcast cannot be predicted theoretically with accuracy. To assess the electromagnetic environment due to fixed RF transmitters, an electromagnetic site survey should be considered. If the measured field strength in the location in which the scale is used exceeds the application RF compliance level above, the scale should be observed to verify normal operation. If abnormal performance is observed, additional measures may be necessary, such as re-orienting or relocating the scale.</p> <p>B) Over the frequency range 150 kHz to 80 MHz, field strengths should be less than 3 V/m.</p>			

Recommended separation distance between portable and mobile RF communications equipment and the M-700.

This scale is intended for use in an electromagnetic environment in which radiated RF disturbances are controlled. The customer or the user of the scale can help prevent electromagnetic interference by maintaining a minimum distance between portable and mobile RF communications equipment (transmitters) and the scale as recommended below, according to the maximum output power of the communications equipment.

Rated maximum output power of transmitter W	Separation distance according to frequency of transmitter m		
	150 kHz to 80 MHz $d = 1,2\sqrt{P}$	80 MHz to 800 MHz $d = 1,2\sqrt{P}$	800 MHz to 2,5 GHz $d = 2,3\sqrt{P}$
0.01	0.12	0.12	0.23
0.1	0.38	0.38	0.73
1	1.2	1.2	2.3
10	3.8	3.8	7.3
100	12	12	23







For transmitters rated at a maximum output power not listed above, the recommended separation distance  $d$  in meters (m) can be estimated using the equation applicable to the frequency of the transmitter, where  $p$  is the maximum output rating of the transmitter in watts (w) according to the transmitter manufacturer.



NOTE1) At 80 MHz and 800 MHz, the separation distance for the high frequency range applies.

NOTE2) These guidelines may not apply in all situations. Electromagnetic propagation is affected by absorption and reflection from structures, objects and people.



## Error Messages

<p><b>Low Battery</b> The scale's alkaline AA type batteries are flat; please replace the batteries.</p>	
<p><b>Overload</b> This indicates that the scale's load sensor(s) have been overloaded. Reduce the loading and retry.</p>	
<p><b>Counting Error</b></p> <ol style="list-style-type: none"> <li>1. The signal from the load cells is too high. Please remove any weight from the scale and try to power on again. If the scale continues to show the error message, it indicates a fault with the electronics or wiring.</li> <li>2. The signal from the load cells is too low. Please remove any weight from the scale and try again. If the scale continues to show the error message, it indicates a fault with the electronics or wiring.</li> </ol>	 
<p><b>High/Low Zero Count</b></p> <ol style="list-style-type: none"> <li>1. The scale is above its zero range. Please remove any weight from the scale and power on again. If the scale continues to show the error message, it indicates a fault with the electronics.</li> <li>2. The scale is below its zero range. Check there is nothing jammed underneath the scale and power on again. If the scale continues to show the error message, it indicates a fault with the electronics.</li> </ol>	 
<p><b>EEPROM Error</b> This indicates there is a fault with the scale's software and is normally caused by a fault with the load cell or wiring. Contact your local service representative.</p>	

<p><b>EU Authorized Representative:</b></p>	 <p><b>Obelis s.a.</b> Bd Général Wahis, 53 B-1030 Brussels Belgium</p>
<p><b>Distributor:</b></p>	<p><b>MARSDEN</b></p> <p>Marsden Weighing Machine Group Ltd, Unit 1, Genesis Business Park, Sheffield Road, Rotherham, UK, S60 1DX</p>
<p><b>EU Importer:</b></p>	<p><b>MARSDEN</b></p> <p>Marsden Weighing Machine Group Europe Ltd, The Black Church, St. Mary's Place, Dublin 7, Dublin, Ireland, D07 P4AX</p>
<p><b>Manufactured by:</b></p>	 <p>Charder Electronic Co., Ltd. No.103, Guozhong Rd., Dali Dist., Taichung City 41262, Taiwan (R.O.C.)</p>





## **MARSDEN**

Unit 1, Genesis Business Park,  
Sheffield Road, Rotherham,  
S60 1DX

Telephone: + 44 (0) 1709 364296

Version 1.1